

广东新锐流铭光电有限公司

Guangdong Lumen Pioneer Opto Co. Ltd

产品规格书

Specification

客户名称 Customer		产品名称 Product Name	3020 车用 LED	版本号 Version	A0
客户料号 Customer P/N		产品型号 Product P/N	W3020DJ1	日期 Date	2022.09.06

研发部 R&D Department		
批准 Approve	审核 Check	制定 Draw
Kevin	戢利进	钟继正
客户承认 Client Approval		
核准 Approval		确认 Audit

LMP® W3020DJ1 LEDs

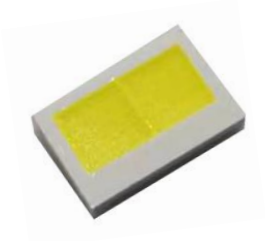

● 产品特征 (Features)

- 倒装芯片氧化铝陶瓷封装
Flip chip aluminum ceramic package
- 尺寸规格: 3.00*2.00*0.70mm
Dimensions: 3.00*2.00*0.70mm
- 高光通量, 低衰减
High luminous Flux ,Low attenuation
- 无铅产品, 符合 RoHs 标准
Lead free products ,RoHs standard

● 应用 (Applications)

- 汽车照明
Automotive lighting



● 光电特性参数 Electrical and optical characteristics. (IF=1000mA ,Ta=25°C)

参数名称 Parameter	符号 Symbol	最小值 Min.	典型值 Typ.	最大值 Max.	单位 unit
色温 Color temperature	CCT	5300	-	7000	K
光通量 Luminous Flux	ϕ		840	-	lm
正向电压 Forward Voltage	VF	6.0	-	6.5	V
显指指数 CRI	Ra	-	70	-	
发光角度 Viewing Angle	$2\theta_{1/2}$	-	120	-	°
热阻 Thermal resistance	R_{th-j}	-	5	-	°C/w

说明：1. 光电参数：产品测试时间 20 毫秒，环境温度 25°C。

Photoelectric parameters: Products test time 20 ms, ambient temperature 25°C.

2. 发光角度为 50%中心光强夹角，可提供 ProSourceLighttools\tracepro\ASAP\ZEMAX 等格式光学文件。
Luminous Angle is 50% of the central light intensity Angle, can provide ProSourceLighttools, tracepro, ASAP, ZEMAX and other optical files.
3. 光通量测量公差为 ±10%，CIE(X,Y)测量值公差为 ±0.007，电压测量值公差 ±0.1V，显色指数公差 ±2。
The luminous flux measurement tolerance is ±10%, CIE(X,Y) measurement tolerance is ±0.007, and voltage measurement tolerance is ±0.1 V; Color rendering index tolerance ±2.

● 最大额定参数 Absolute Maximum Ratings

参数 Parameter	符号 Symbol	额定值 Rating	单位 Unit
正向电流 Forward Current	I_F	50 - 1000	mA
脉冲电流 Current Pulsed	I_{FP}	-	mA
结温 (LED junction temperature)	T_j	150	°C
工作温度(Operating Temperature)	T_{opr}	-40-+85	°C
储存温度(Storage Temperature)	T_{stg}	-40-+100	°C
焊接温度(Soldering Temperature)	T_{sol}	260 (< 10s)	°C
反向电压(Reverse Voltage)	V_r	无反向操作设计	V

说明：1. 最大正向电流或最大脉冲正向电流的先决条件是器件结温低于额定工作结温。

The prerequisite for maximum forward current or pulse forward current is that the device junction temperature is lower than the rated operating junction temperature.

2. 储存温度是指灯珠存储温度，不包含卷盘包装。
Storage temperature refers to the storage temperature of the lamp, excluding packaging materials.

● 光电特性曲线 Typical Electro-Optical Characteristics Curves.

波长 vs 相对光谱 Wavelength vs. Relative intensity

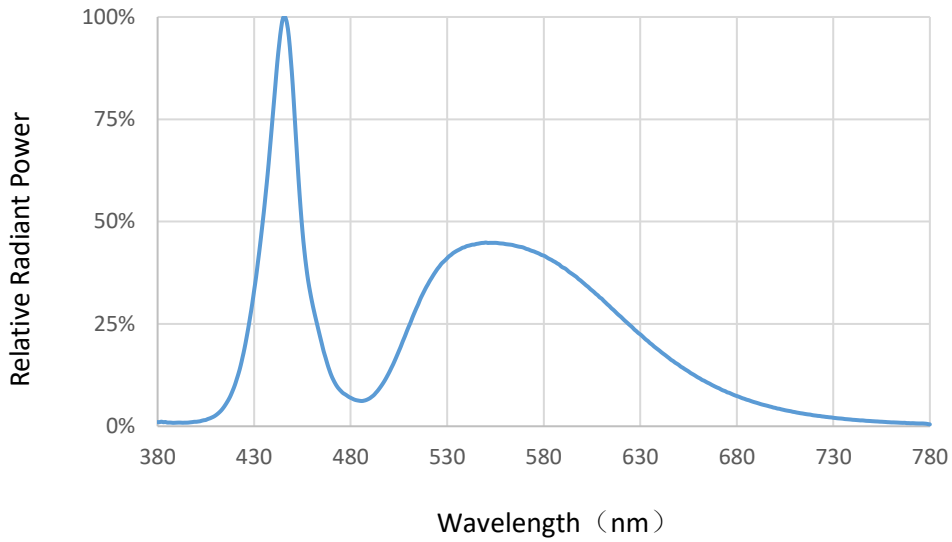

电流 vs 电压关系 Forward current vs. Forward voltage

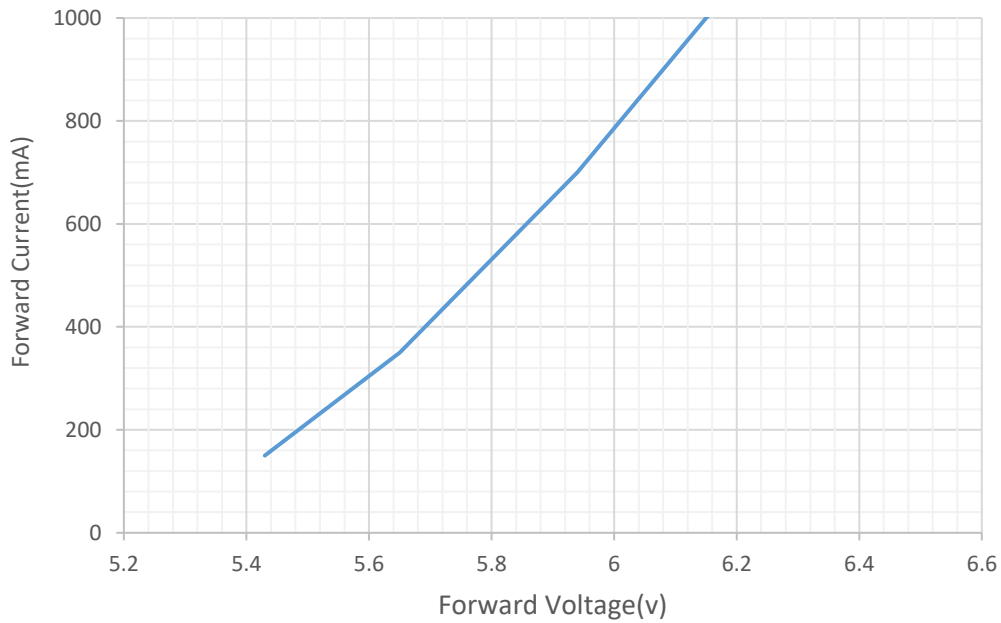

电流 VS 相对光通量关系

Forward current vs. Relative luminous intensity

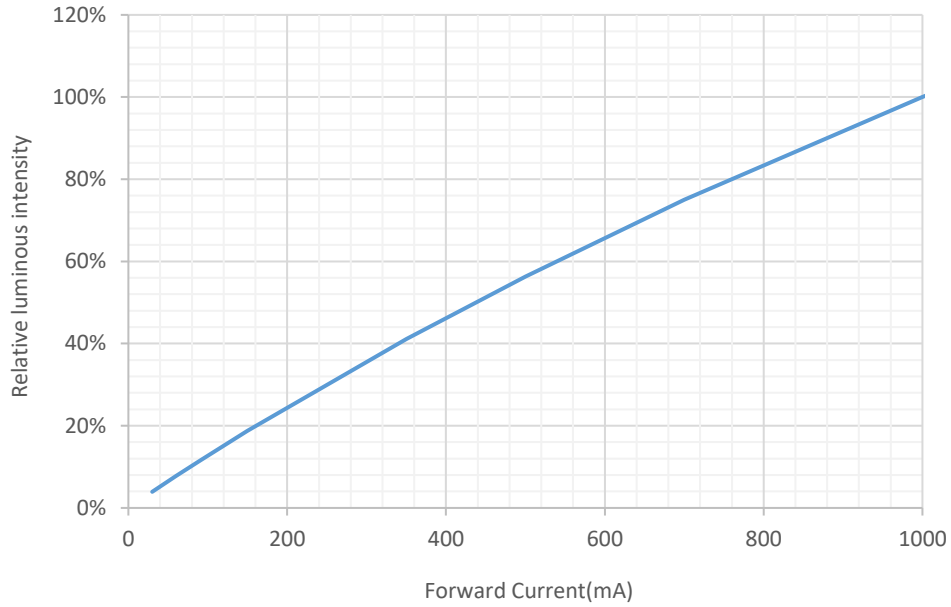

最大驱动电流 vs. 焊脚温度

Maximum driving current vs. Temperature of the pin

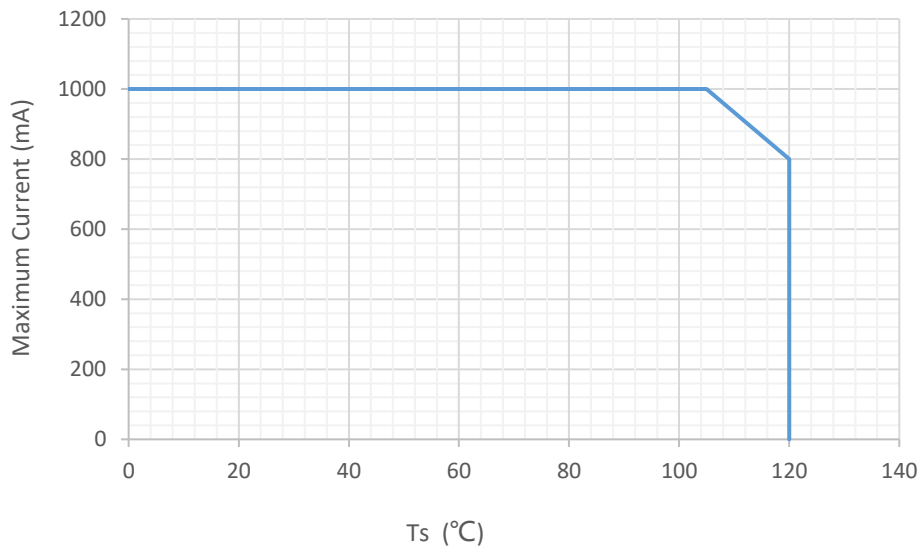

说明：当电流驱动到 1000mA 时，请确保 LED 焊脚温度不超过 105℃， 否则请降低电流使用。

Note: When the current is driven to 1000mA, please make sure that the temperature of LED solder toe does not exceed 105℃, otherwise, please reduce the current.

结温 vs.相对光通量关系

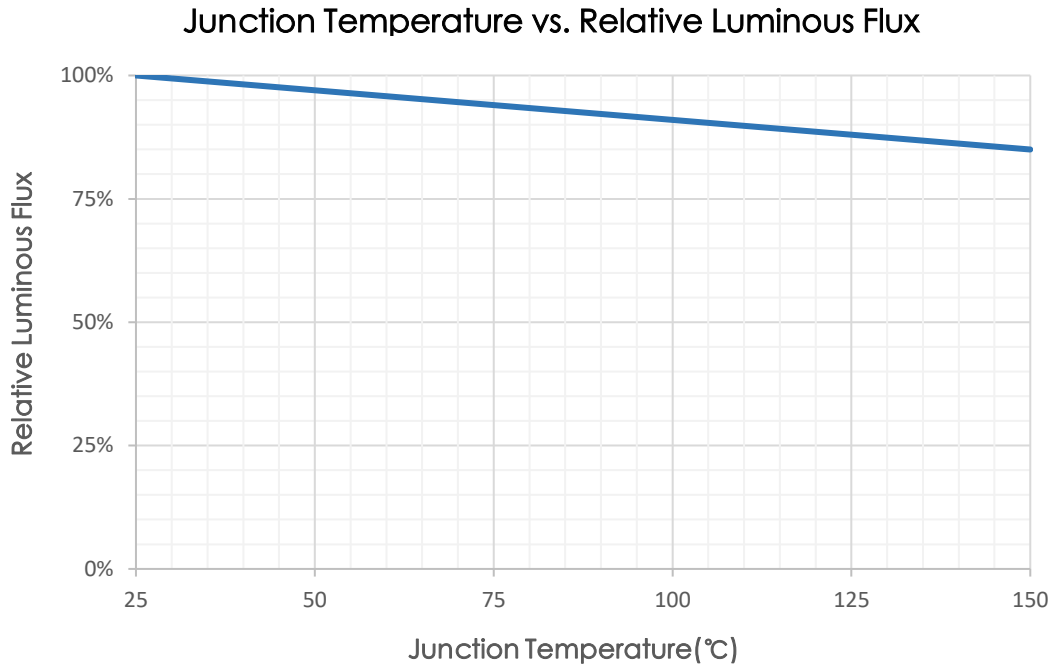

发光角度与相对光强关系

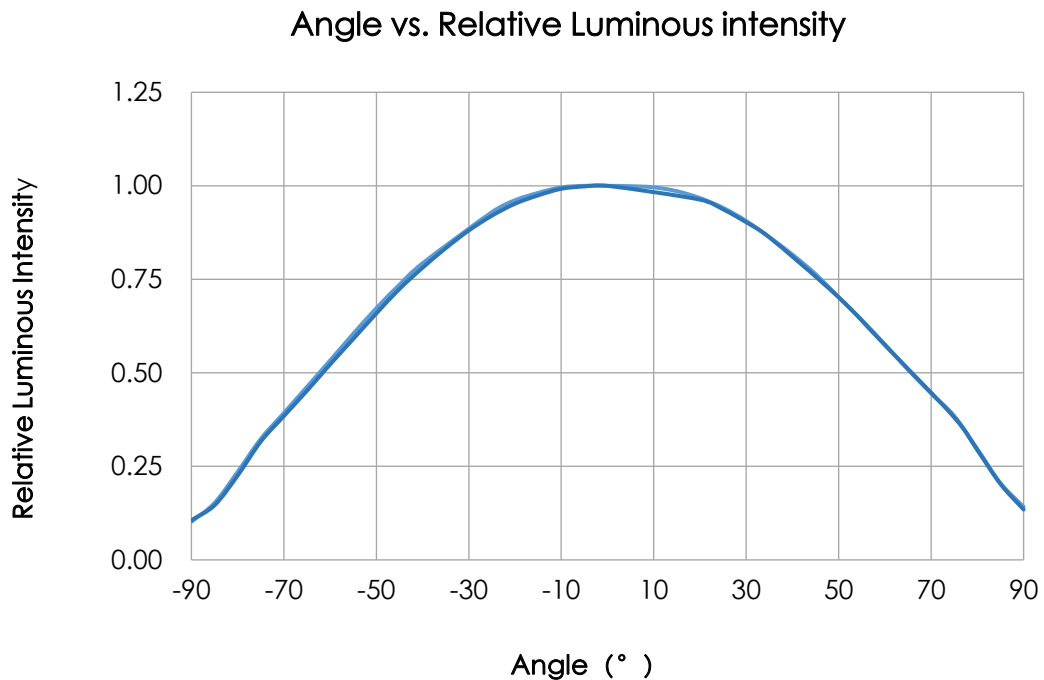

● 出货条码规则 (Code for Shipment)

W3020DJ1 – B0 – 2A – G2 – VW

①

②

③

④

⑤

① 产品型号 Product P/N

② 显色指数等级 Ra level

③ 色区等级 Color Area

④ 亮度等级 Brightness level

⑤ 电压等级 VF level

● 分档规则 (Bin Regulations)

光通量分档 (Luminous Bin Code)

Bin Code	最小值 Min	最大值 Max	单位 Unit	Condition
G2	800	900	LM	IF=1000mA

电压分档 (VF Bin Code)

Bin Code	最小值 Min	最大值 Max	单位 Unit	Condition
VW	6.0	6.5	V	IF=1000mA

● 色度定义 (1931CIE)

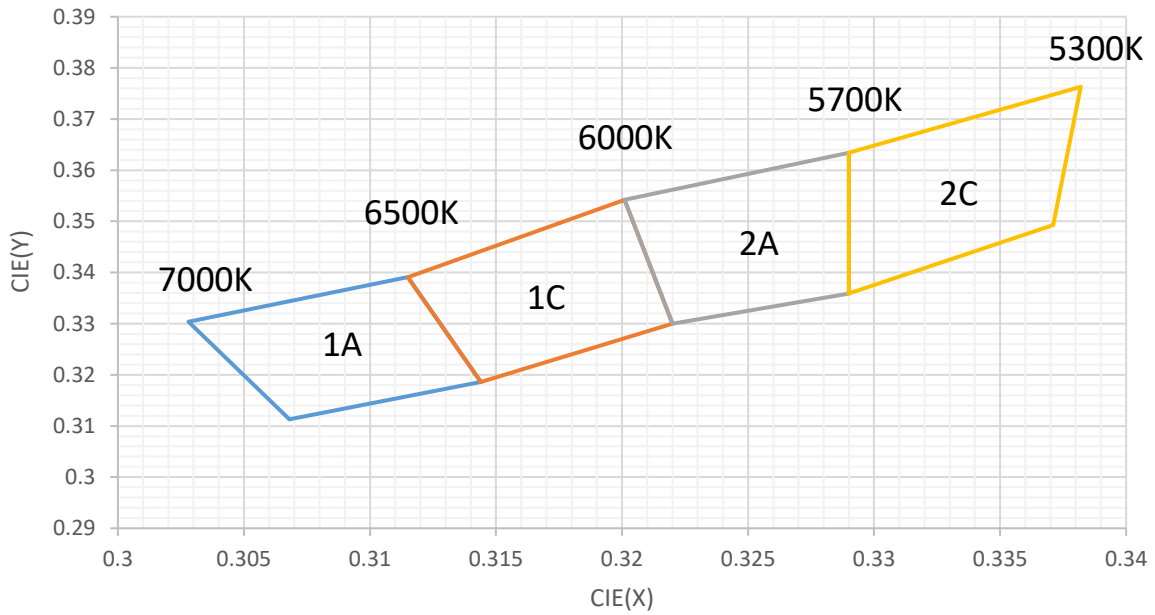

色区格代码	色温范围 (K)	CIE(X)	CIE(Y)
2C	5300-5700	0.329	0.3359
		0.329	0.3634
		0.3382	0.3763
		0.3371	0.3493
2A	5700-6000	0.322	0.33
		0.3201	0.3542
		0.329	0.3634
		0.329	0.3359
1C	6000-6500	0.3144	0.3186
		0.3115	0.3391
		0.3201	0.3542
		0.322	0.33
1A	6500-7000	0.3068	0.3113
		0.3028	0.3304
		0.3115	0.3391
		0.3144	0.3186

● 成品尺寸图 (Packing Dimensions)

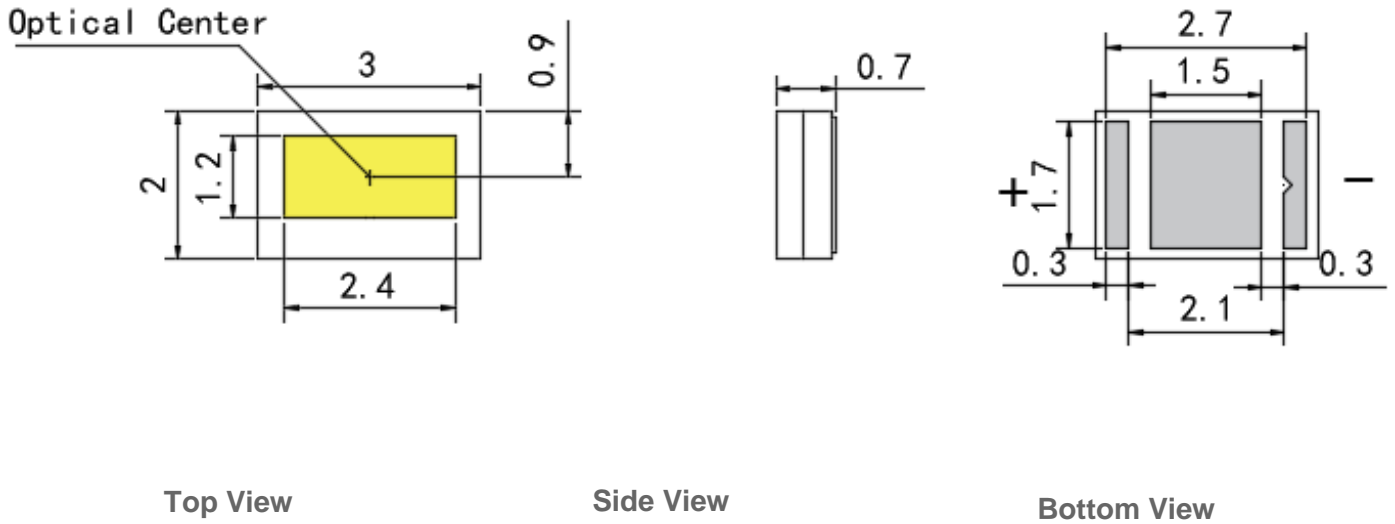

● 推荐焊盘尺寸图 (Recommended PCB Solder Pad)

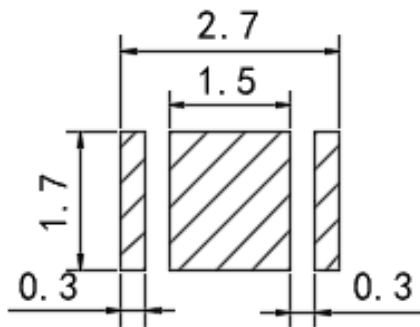

备注 Notes:

1. 所有尺寸均以 mm 为单位。
All dimensions are in millimeter.
2. 在没有明确标注的情况下，公差均为 $\pm 0.1\text{mm}$ 。
Tolerance is $\pm 0.1\text{mm}$ unless otherwise specified.

● 回流焊特性 (Reflow Soldering Characteristics)

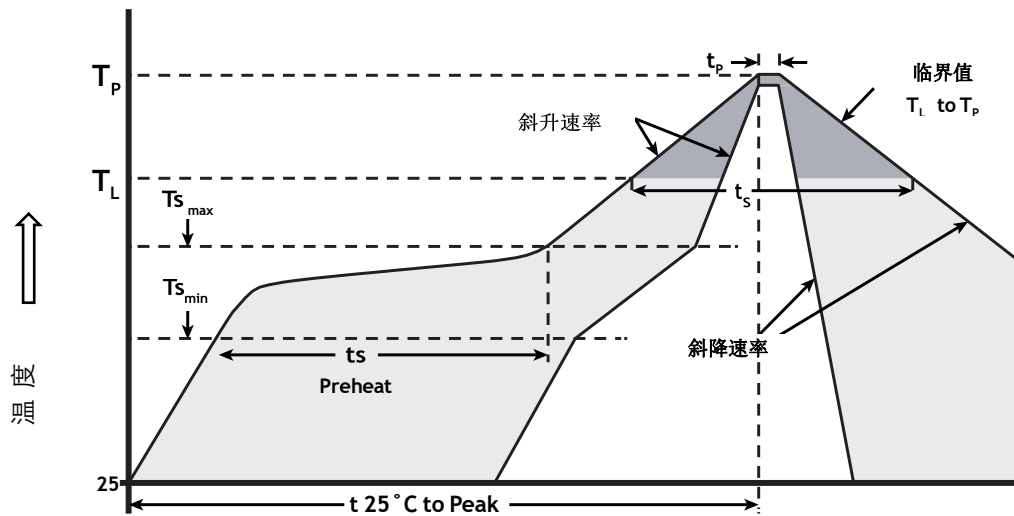

温度分布特点	锡铅共晶焊料	无铅焊料
斜升速率 (Tsmax 到 Tp)	最大值 3°C/秒	最大值 3°C/秒
最低预热温度 (Tsmin)	100°C	150°C
最高预热温度 (Tsmax)	150°C	200°C
预热时间 (Tsmin 到 Tsmax)	60-120 秒	60-180 秒
液相温度 (TL)	183°C	217°C
温度维持在 TL 以上的时间 (tL)	60-150 秒	60-150 秒
封装体峰值温度 (Tp)	215°C	260°C
指定实际峰值温度 5°C 内的时间	10-30 秒	20-40 秒
斜降速率 (Tp 到 TL)	最大值 6°C/秒	最大值 6°C/秒
25°C 到峰值温度的时间	最大值 6 分钟	最大值 8 分钟

说明：1. 温度分布特点请参照 IPC/JEDEC J-STD-020C

2. 产品湿气敏感等级 2 (MSL2).
Moisture sensitivity grade 2 (MSL2).

● 信赖性测试项目及条件 (Reliability Test)

NO.	测试项目 Test Item	测试条件 Test Conditions	频次 Rate	判据 Crite
1	高温老化 High temperature Operating	Ta=85°C, I _f =1000mA	1000hrs	0/22
2	高温高湿老化 High Temperature and High Humidity Operating	85°C/85%RH, I _f =800mA	1000hrs	0/22
3	高温储存 High Temperature Storage	Ta=105°C	1000hrs	0/22
4	低温储存 Low Temperature Storage	Ta=-40°C	1000hrs	0/22
5	冷热冲击 Thermal Shock	-40°C(15min)~(10S)~105°C(15min)	500cycle	0/22
6	耐焊接性 Resistance to Soldering Heat	Tsol*=260°C 10sec. (Sn-3.0Ag-0.5Cu)	3times	0/22

● 失效判定标准 (Criteria For Judging Damage)

测试项目 Test Items	符号 Symbol	测试条件 Test Condition	判定标准 Criteria For Judging Damage
正向电压 Forward Voltage	V _F	I _f =1000mA	> U.S.L*1.1
反向电流 Reverse Current	I _R	V _R =5V	I _R > 1uA
光强 Luminous Intensity	I _v	I _f =1000mA	< L.S.L*0.7

* U.S.L: 定义为规格上限, L.S.L: 定义为规格下限.

● 使用说明及注意事项(Precautions in Handling & use)

1.禁止将LED放在潮湿的地方，应存放温度在5℃~30℃之间，相对湿度在30%以下的条件。

Do not place the LED in damp places, Storage temperature between 5 °C- 30 °C, Relative humidity under 30%.

2.铝箔袋开封后建议在24小时内过完回流焊，车间温湿度需管控在≤30℃/60%RH.

After opening the package, it is recommended to finish the reflow within 24 hours. The workshop conditions are ≤30° C/60%RH.

3. 如果湿度卡读数为>60%(23℃±5)，则led在贴片前需要烘烤,需将贴片卷盘放入60℃烤箱烘烤24小时.

LEDs require baking before mounting, if humidity card reading is >60% at 23±5°C.the patch reel should be baked in a 60 °C oven for 24 hours.

4.LED对静电放电和浪涌非常敏感，处理led时，建议使用接地腕带或防静电手套.

LEDs are sensitive to electrostatic discharge and surges, When handling LEDs, using grounding wrist bands or anti static gloves is recommended.

5.LED贴片建议采用高温焊料，使用八温区以上回流焊设备，且回流过程中的峰值温度 < 260℃，峰值温度的焊接时间 < 10s.

It is recommended to use high temperature solder for LED patch. Use reflow welding equipment above eight temperature zone, and the peak temperature during reflow is less than 260°C, and the welding time of peak temperature is less than 10s

6. LED禁止使用有机溶剂（特别是丙酮）或超声波状态下清洗.

Do not use organic solvents (especially acetone) or ultrasonic cleaning for leds.

7. LED应避免使用尖锐辅助工具（比如镊子或指甲）对表面硅胶施加外力，造成led破损。

LED should avoid using sharp auxiliary tools (such as tweezers or nails) to apply external force on the surface of the silicone, causing LED damage

● 塑料镊子
Plastic Tweezers

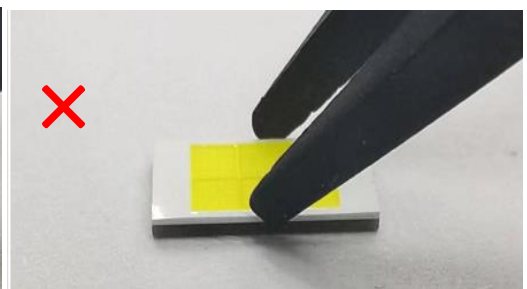
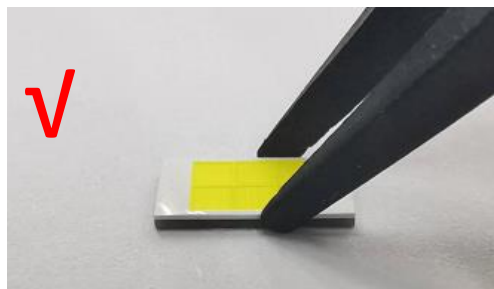

● 金属镊子
Metal Tweezers

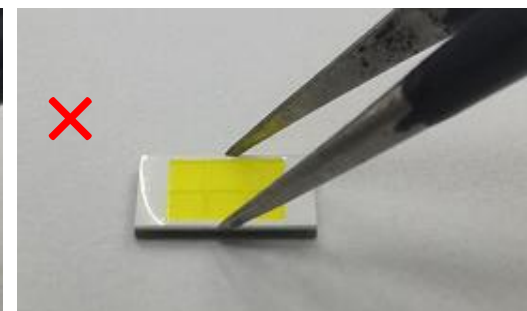
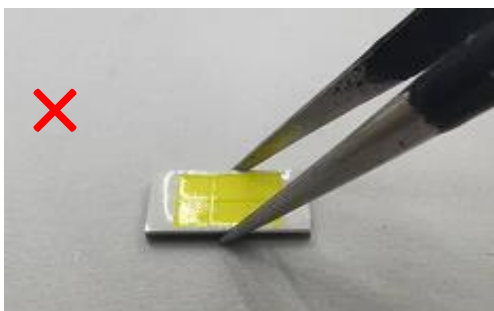

● 变更履历表 (Change of resume)

序号	变更日期	变更人	版本	变更内容
1	2022.09.06	钟继正	A0	更新版本